

KYOTA™

M673 Kenko Massage Chair

User's Manual

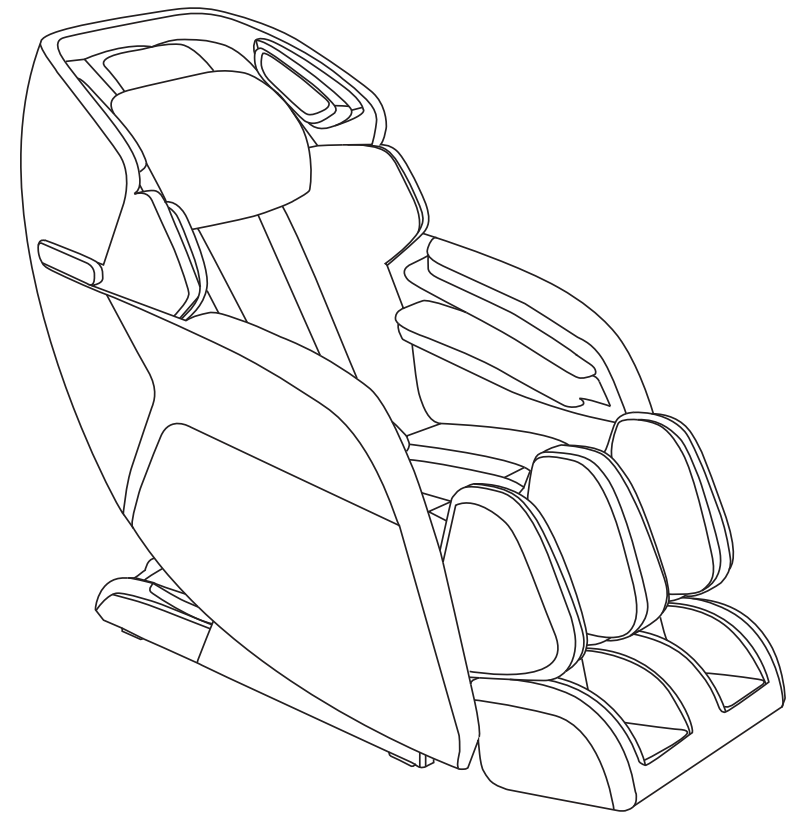

KYOTA™

Kyoto Massage Chairs

800-242-0761 | www.kyotamassagechairs.com

www.kyotamassagechairs.com

Congratulations and thank you for trusting Kyota Massage Chairs. Combined with healthy eating, exercise, and a good sleep regimen, your massage chair is a great way to take care of your body and mind. This will lead to a happy, productive lifestyle.

Please read and follow all safety and operating instructions listed in this user manual prior to use. Basic precautions should always be used when operating an electrical appliance.

Contact Kyota Massage Chairs' Technical Support Team with any questions or concerns at 800-242-0761. Our dedicated specialists will be happy to assist you!

Please Note: We reserve the right to make changes to information published in this manual, including but not limited to, specifications and product descriptions. These changes may be made at any time and without notice. This manual supersedes and replaces all information supplied prior to the publication hereof.

Table of Contents

| | | |
|--------------------|---------------------------|---|
| Preparation | Safety Precautions | 2 |
| | Massage Chair Parts | 6 |

| | | |
|--------------------------------|--|----|
| Usage & Maintenance | Installation & Placement Instructions..... | 7 |
| | Remote & Massage Chair Operation | 13 |
| | Connecting to Bluetooth..... | 16 |
| | Product Care & Storage | 17 |

| | | |
|-------------------------|-----------------------|----|
| Additional Info. | Troubleshooting | 18 |
| | Specifications | 19 |

Watch the Assembly Video:
<https://kyotamassagechairs.com/assembly-tutorials/M673>

IMPORTANT SAFETY INSTRUCTIONS

CAUTION

- TO REDUCE THE RISK OF ELECTRIC SHOCK, DO NOT REMOVE COVER. THERE ARE NO SERVICEABLE PARTS INSIDE.
- TO REDUCE RISK OF FIRE OR ELECTRIC SHOCK, DO NOT EXPOSE THE MASSAGE CHAIR TO RAIN OR MOISTURE.



This symbol indicates the presence of uninsulated “dangerous voltage” within the massage chair’s enclosure that may be of sufficient magnitude to constitute a risk of electric shock.



This symbol indicates the presence of important operating and maintenance instructions in the literature accompanying the massage chair.

This massage chair is intended for household use only.

When using an electrical appliance, basic precautions should always be followed.

Read all instructions before using this massage chair.

⚠ DANGER - To reduce the risk of electric shock:

1. Always unplug this massage chair from the electrical outlet immediately after using and before cleaning.
2. If liquid is accidentally spilled onto the chair, remove the power plug from the electrical outlet immediately. Do not use wet hands to connect or disconnect the power plug from the electrical outlet.
3. Do not operate during a lightning storm.
4. Although operation will be stopped automatically by the Auto Timer function, always remember to turn off the main power switch after use.
5. Do not place the power cord under the chair or under any other heavy objects.
6. Do not wind the power cord around the chair as this may damage the cord and result in a fire or electric shock.
7. Do not operate the chair with a damaged cord or with an extension cord.
8. Do not use the chair if the electrical outlet is loose.

| | |
|----------------------------------|--------------------------|
| Model | M673 Kenko Massage Chair |
| Dimension of Main Body (in) | 62 x 30 x 48 (L x W X H) |
| Necessary Clearance to Wall (in) | 4 |
| Net Weight (lbs) | 181 |
| Shipping Weight (lbs) | 286 |
| Max. User Weight (lbs) | 264 |
| Voltage | 110-120V~ 60Hz |
| Fuse | 3.15 AMP |
| Power Consumption | 1.6A |

Troubleshooting

If you encounter problems while operating your Kyota M673 Kenko massage chair, try the suggestions below. If the issue(s) persist, flip the main power switch on the back of the chair to the Off position and remove the power plug from the outlet. Contact Infinity's technical support team at 800-242-0761 for service.

Do not disassemble or attempt to repair the massage chair yourself. Doing so will void the warranty and Kyota will not bear any responsibility for any subsequent consequences.

| Problem | Possible Cause/Solution |
|---|---|
| The massage chair is connected to a power source, but is not functioning. | <ul style="list-style-type: none"> • Check that the main power switch on the back of the chair is in the On position. • Check that the power plug is inserted properly and the power outlet is functioning properly. • Press the Power button on the remote. • Check the fuse next to the main switch in the back of the chair. |
| Sounds are coming from the massage mechanism. | It is normal for the motors to make noise while operating or rubbing against the backrest area. |
| No sound is coming from the speakers. | Ensure the volume on your device is turned up and the Bluetooth pairing was successful. |
| Backrest or legrest will not extend or retract. | There may be too much pressure placed on the backrest or legrest. Reduce the weight or pressure on the backrest or legrest. |
| The seat or legrest airbag is not working. | Check to see if there is an air tube blockage or if an air tube is pinched. If so, clear the air tube or straighten it out. |

Safety Precautions

⚠ WARNING - To reduce the risk of burns, fire, electric shock, or injury:

1. This massage chair should never be left unattended when plugged in. Unplug from outlet when not in use, and before putting on or taking off parts.
2. Do not operate under blanket or pillow. Excessive heating can occur and cause fire, electric shock, or other injury.
3. Close supervision is necessary when this chair is used by or near children, pets, or disabled individuals. Keep children and pets away from extended foot support.
4. Use this massage chair only for its intended use as described in this manual. Do not use attachments not recommended by Infinity.
5. Never operate this massage chair if it has a damaged cord or plug, if it is not working properly, if it has been dropped or damaged, or if it has been damaged by water. Contact Kyota's technical support team at 800-242-0761 for assistance.
6. Do not move or carry this massage chair by the power cord, or use the cord as a handle.
7. Keep the cord away from heated surfaces.
8. Never operate the massage chair with the air openings blocked. Keep the air openings free of lint, hair, and other debris.
9. Never drop or insert any object into any opening.
10. Do not use outdoors.
11. Do not operate where aerosol (spray) products are being used, or where oxygen is being administered.
12. To disconnect, turn all controls to the OFF position, then remove the plug from the outlet.
13. Use heated surfaces carefully. May cause serious burns. Do not use over sensitive areas or on areas with poor circulation. The unattended use of heat by children or disabled individuals may be dangerous.
14. Never use pins or other metallic fasteners with this chair.
15. Never remove the cover from this chair. Do not use the chair when the upholstery is ripped, torn, or removed. This may cause injury or malfunction. Carefully examine the covering before each use. Call Kyota's technical support team if the covering shows any sign of deterioration, such as blistering, peeling, cracking, or ripping.
16. Keep dry. Do not operate the massage chair in a wet or moist environment. Do not use the chair when your body is wet, or operate with wet hands.
17. Do not use the massage chair while wearing excessively loose clothing or jewelry.
18. Keep long hair away from massage chair openings and moving parts during use.
19. Do not insert your hand or foot along the path of the massage rollers during use.
20. Any individual who is pregnant; uses a pacemaker; suffers from diabetes, phlebitis, and/or thrombosis; is at an increased risk of developing blood clots due to recent surgery; or is being treated or has been diagnosed with any other medical condition or physical injury should consult a physician before using this massage chair.
21. This massage chair is designed as a non-professional solution to help soothe tired, aching muscles. It is not intended for self-treatment of conditions that should be managed by a qualified healthcare provider. If your ailments and symptoms persist or worsen after use, contact your doctor immediately.

22. Do not use this chair if you are not feeling well.
23. Stop operation immediately if you experience any discomfort.
24. Do not fall asleep during the massage session.
25. Do not operate after consuming pain killers, sedatives, or alcohol.
26. Do not use this chair in combination with other therapeutic equipment or items such as an electric blanket, as this may result in ineffectiveness or injury.
27. Do not stand on or in this massage chair. Use only while seated.
28. Do not disassemble any part of the chair. Touching the internal components may result in malfunction or electric shock. Instead, contact Infinity's technical support team immediately for professional assistance.
29. Always position the massage chair on a flat, level surface.
30. Do not operate for more than 30 consecutive minutes. Turn off the chair and allow it to rest for 30 minutes before using again. This will prolong the life of the chair.
31. Do not perform continuous massage on the same spot of your body for more than 5 minutes at a time, as this may result in excessive stimulation and may have adverse effects.
32. Never use the chair on open skin wounds or swollen, inflamed areas.
33. Do not apply massage rollers directly on the head, elbow or knee joints, torso, or abdomen.
34. If the power goes off during use, be sure to turn the power switch to the OFF position and pull the power plug out from the outlet to prevent damage from occurring when the power is restored.

SAVE THESE INSTRUCTIONS

Grounding Instructions

This product must be grounded. If it should malfunction or break down, grounding provides a path of least resistance for the electric current to reduce the risk of electric shock.

This product is equipped with a cord with an equipment-grounding conductor and a grounding plug. The plug must be plugged into an appropriate outlet that is properly installed and grounded in accordance with all local codes and ordinances.

DANGER: Improper connection of the equipment-grounding conductor can result in a risk of electric shock.

Check with a qualified electrician or serviceperson if you are in doubt as to whether the product is properly grounded. Do not modify the plug provided with the product. If it does not fit the outlet, have a proper outlet installed by a qualified electrician.

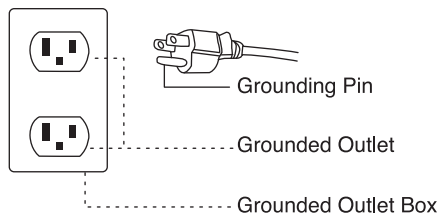

Storing the Massage Chair

- Disconnect the massage chair from the power source after use.
- Do not expose the massage chair to direct sunlight, high temperature, or high humidity. This could cause fading or other damage to the upholstery.
- Do not put heavy objects on the massage chair.
- If the outer cover is torn or the mechanism is damaged, stop using the chair and contact Infinity for assistance.

Cleaning the Massage Chair

Follow the steps below to clean your massage chair:

- Remove the main plug from the outlet.
- Clean the synthetic leather, controller, cords with a dry cloth.
- If necessary, you can dampen a soft cloth with a neutral cleaning solution or water to clean the synthetic leather. Lysol wipes are another safe and easy way to clean this material. Then, wipe it with a dry cloth and let air dry.
- Any cloth material of the chair (e.g., the inside of the arm airbags or calf airbags) can be spot cleaned with a soft cloth dampened with a weak neutral detergent and gently clean where necessary. Avoid cleaning the fabric too often so as to avoid wear and tear.
- To clean any plastic parts of the chair (e.g., the base), use a soft cloth lightly soaked in a neutral detergent. Then, wipe again with a water-dampened cloth. Finally, wipe it with a clean, dry cloth.

Caution

- Do not immerse the chair in water.
- Never use scouring pads, abrasive cleaning agents (e.g., benzene or thinner), or harsh chemicals such as petroleum or acetone to clean the chair. Additionally, never use heat to dry the chair after cleaning. These items may cause fading or other damage to the upholstery.
- Any additional servicing should be performed by an authorized service representative. This chair has no user serviceable parts inside.

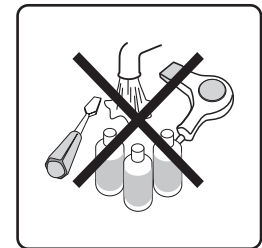

Please Note: All of the above settings are saved even when the machine is turned off suddenly.

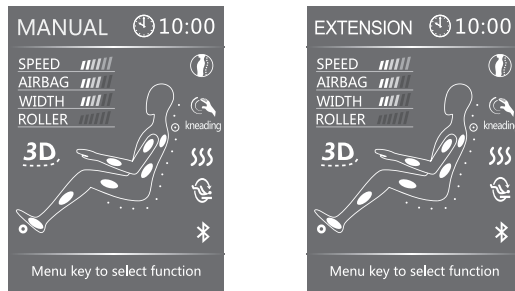

Home screen in Manual Mode Home screen in Auto Mode

Please Note: All of the above settings are saved even when the machine is turned off suddenly.

- During use, press MENU twice to return to the home screen immediately.
- On the home screen, under either Manual Mode or Auto Mode, press the left and right button to adjust air pressure intensity. Under Manual Mode, press up and down to adjust massage roller speed.
- Press AUTO to choose Auto Programs directly.

Connecting to Bluetooth

1. Go to your mobile or tablet device's Bluetooth settings and search for nearby Bluetooth devices. Choose the "M673-KENKO".
2. After pairing the chair with your device, simply use your phone or tablet's music app to play the tunes or audiobook of your choice.

FCC Statement

1. This device complies with Part 15 of the FCC Rules. Operation is subject to the following two conditions:
 - (1) This device may not cause harmful interference, and
 - (2) This device must accept any interference received, including interference that may cause undesired operation.
2. Changes or modifications not expressly approved by the party responsible for compliance could void the user's authority to operate the equipment.

This equipment has been tested and found to comply with the limits for a Class B digital device, pursuant to part 15 of the FCC Rules.

These limits are designed to provide reasonable protection against harmful interference in a residential installation. This equipment generates, uses and can radiate radio frequency energy and, if not installed and used in accordance with the instructions, may cause harmful interference to radio communications. However, there is no guarantee that interference will not occur in a particular installation.

If this equipment does cause harmful interference to radio or television reception, which can be determined by turning the equipment off and on, the user is encouraged to try to correct the interference by one or more of the following measures:

- Reorient or relocate the receiving antenna.
- Increase the separation between the equipment and receiver.
- Connect the equipment into an outlet on a circuit different from that to which the receiver is connected.
- Consult the dealer or an experienced radio/TV technician for help.

FCC Radiation Exposure Statement:

This equipment complies with FCC radiation exposure limits set forth for an uncontrolled environment. In order to avoid the possibility of exceeding the FCC radio frequency exposure limits, human proximity to the antenna shall not be less than 20cm (8 inches) during normal operation.

Massage Chair Parts

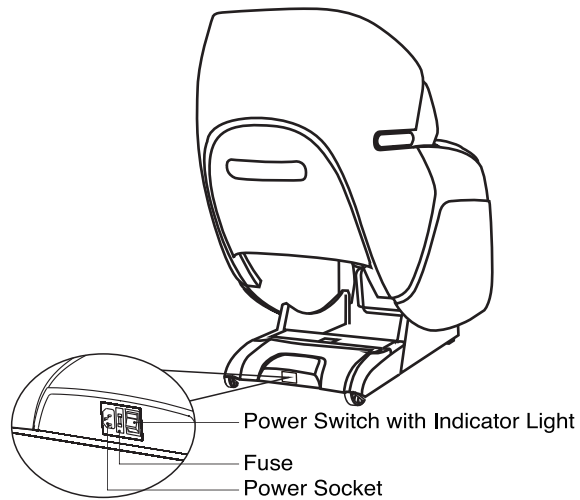
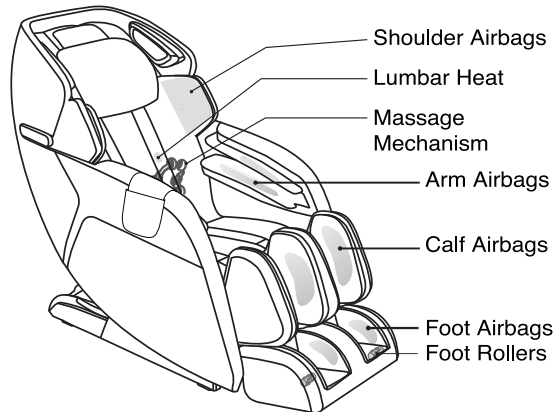
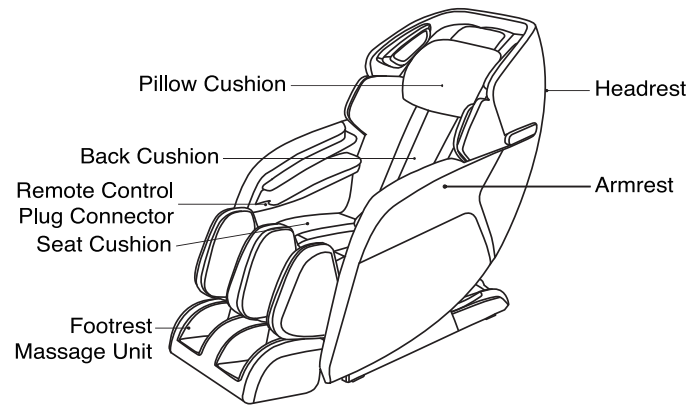

Remote & Massage Chair Operation

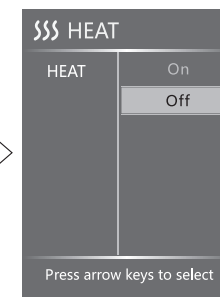
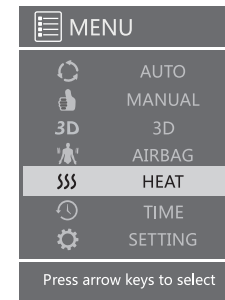

Heat: Press MENU, select HEAT, then press right to turn on or off.

Time: Press MENU, select TIME, then press up or down to choose 10 minutes, 20 minutes, or 30 minutes. The default setting is 20 minutes.

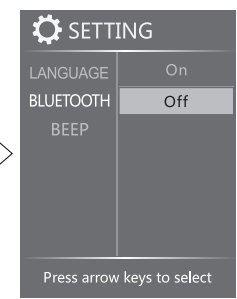
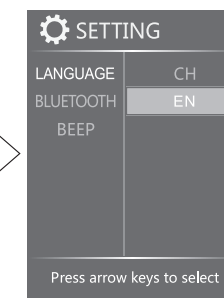
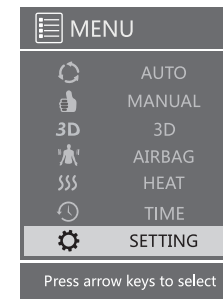
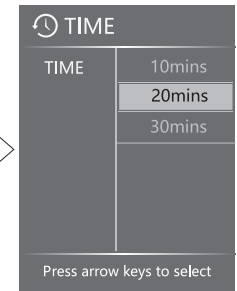
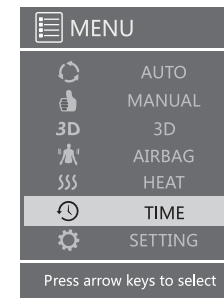

Setting: Press MENU button, then choose SETTING. Use up or down button to toggle Language, Bluetooth, or Beep settings.

Language: Under SETTING > LANGUAGE function, press right button, then press up or down button to select CHINESE or ENGLISH.

Bluetooth: Under SETTING > BLUETOOTH function, press up or down button to turn Bluetooth on or off.

Beep: Under SETTING > BEEP function, press up or down button to turn Beep on or off.

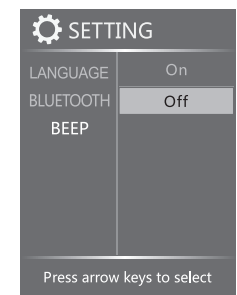

Please Note: All of the above settings are saved even when the machine is turned off suddenly.



Rollers: Press MENU button, then choose ROLLER. Adjust the roller speed from 1 to 3, or select Off to stop the rollers.

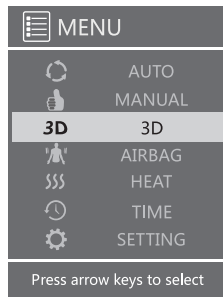

3D: Press MENU, select 3D. Press right button, then press up or down button to choose 3D force from 1 to 5.

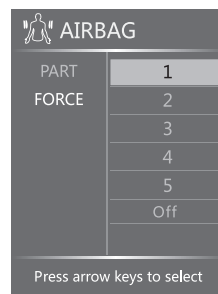
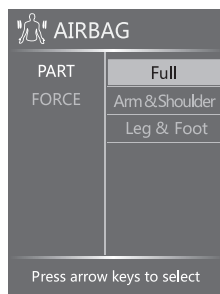
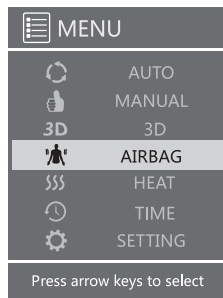

Airbags: Press MENU button, then choose AIRBAG. Use up/down button to choose airbag PART and FORCE.

Part: Under AIRBAG PART function, press right button, then press up/down button to choose Full, Arm & Shoulder or Leg & Foot.

Force: Under AIRBAG FORCE function, press right button, then press up or down button to choose airbag force from levels 1 to 5, or to stop the airbag.

Watch the Assembly Video:
<https://kyotamassagechairs.com/assembly-tutorials/M673>

Unpacking & Installing the Massage Chair

1. Remove all chair parts and accessories from the cartons.
2. Before beginning installation, please verify that all components are included (check with the packing list carefully).

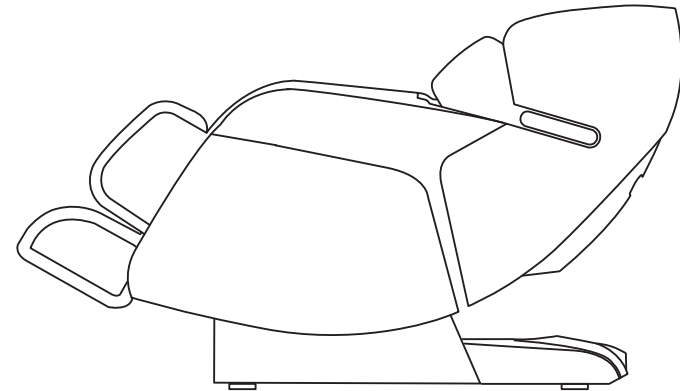

Package Contents

- Massage Chair Body
- Footrest
- Power cord
- Remote
- Remote Pocket
- Spare Fuse (2)
- Spring Clips (2)
- User's Manual
- Warranty Card

If you are missing any of the above items, please do not return your chair. Simply contact Kyota Massage Chairs at 800-242-0761 and we'll be happy to assist you!

Installation & Placement Instructions

- Lift the footrest unit and fit the hook of the footrest unit into the Chair Body Pin located at the Seat base (keep the hook leveled with the coupling shaft). Connect one side first then the other. Secure the Spring Clip at the end of the pin.

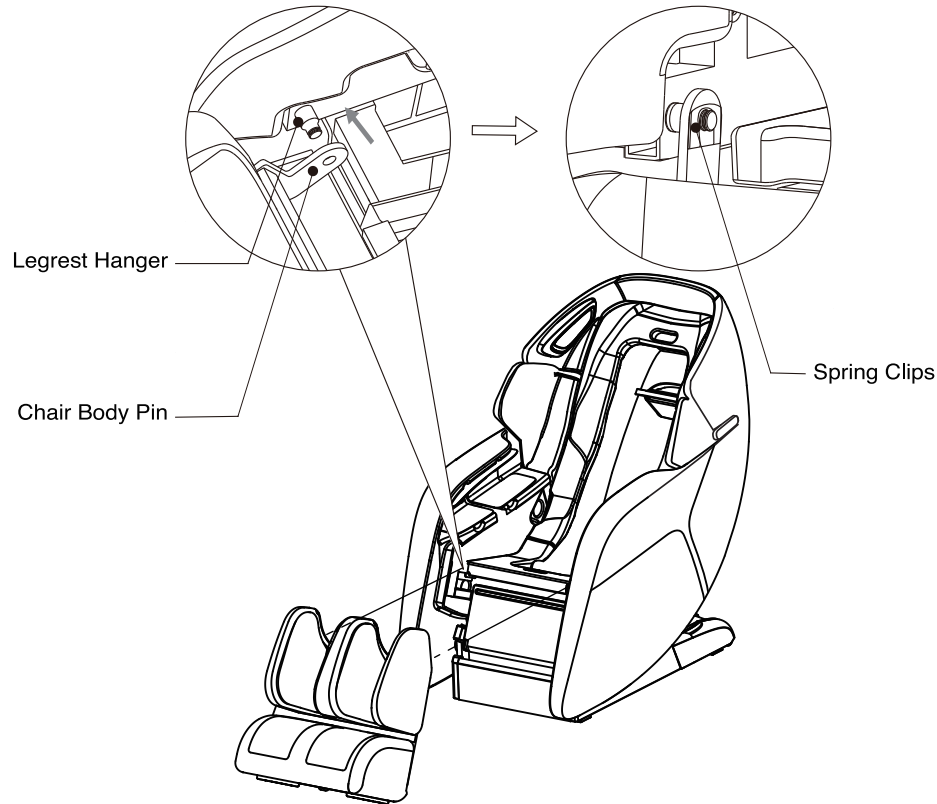

- Raise the footrest, thread the Air Hoses into the Air Nozzle, and fit the Air Valve plug into the Air Valve Port (located on the front side of seat base). Make sure they are well secured. Check the illustration below for reference.

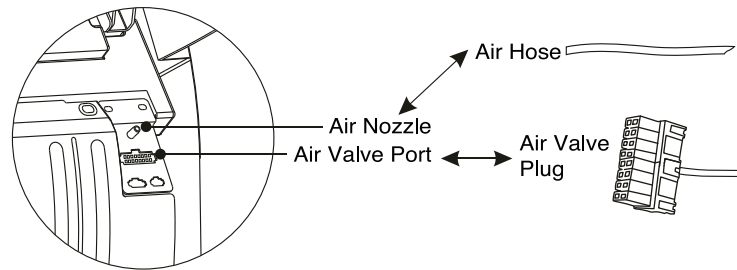

Remote & Massage Chair Operation

Auto Programs

- Select AUTO to display the Auto Programs menu.
- Toggle between the six (6) auto programs: Sports Refresh, Extension, Rest & Sleep, Working Relief, Neck & Shoulder, and Waist & Spine. Press OK to select desired program. Selected program will show on the home screen.

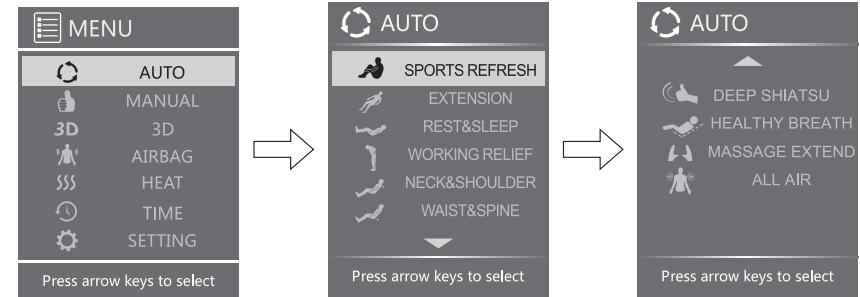

Manual Options

- Select MANUAL to display the Manual options menu.
- Press up/down buttons to choose Mode, Part, Width, Speed, Roller, or Zero Gravity.

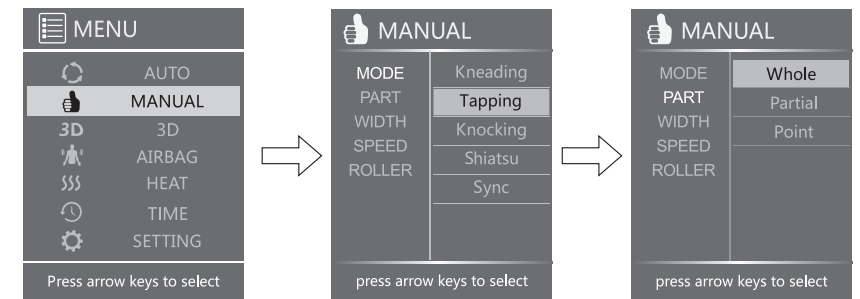

Mode: Under Mode function, press right button, then press up/down button to select massage technique. Choose from Kneading, Tapping, Knocking, Shiatsu, or Sync.

Part: Under Part function, press right button, then press up/down button to select Whole, Partial, or Point.

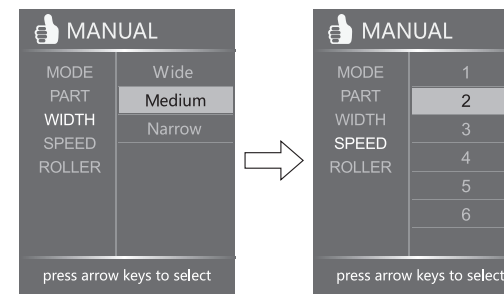

Width: Under Width function, press right button, then press up or down button to select Wide, Medium, or Narrow.

Speed: Under Speed function, press right button, then press up or down button to choose a speed between 1 and 6.

Remote & Massage Chair Operation



Power

Press this button to turn the massage chair on or off.



Menu

Display the Auto Programs, Manual Programs, 3D Massage, Airbags, Heat, and Settings.

Shoulder Position Adjust

- Press and hold these buttons to adjust the rollers to the desired position while using Point massage in Manual mode.
- During body scanning, use these buttons to adjust the position of the massage roller mechanism.



Auto Program

- Press this button to display the Auto Program Menu.
- Press during an auto program to toggle between programs. The active program displays at the top of the status screen.



Foot Roller On/Off

Press this button to turn the foot rollers on or off.



Navigation

Use the UP/DOWN/LEFT/RIGHT arrow buttons to navigate the screen. Press OK to select.



Back Up/Down

Press and hold to recline or raise the backrest. Release button to stop.



Feet Up/Down

Press and hold to raise or lower the footrest. Release the button to stop.



Lumbar Heat

Press to turn lumbar heat on or off.



Zero Gravity Position

Press to enter zero gravity position. Press again to return chair to its upright position.

Installation & Placement Instructions

5. Connect the remote control cable to the massage chair's plug connector, then tighten the screw cap clockwise to secure the connector in place.

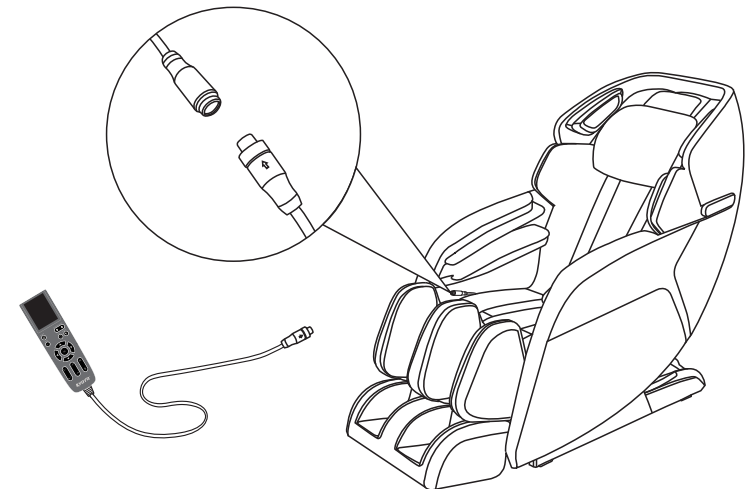

6. Connect the power cable to the product power socket located at the power box of the product.
7. Switch ON the power located at the back of power box, raise the backrest of the product to fully upright position.

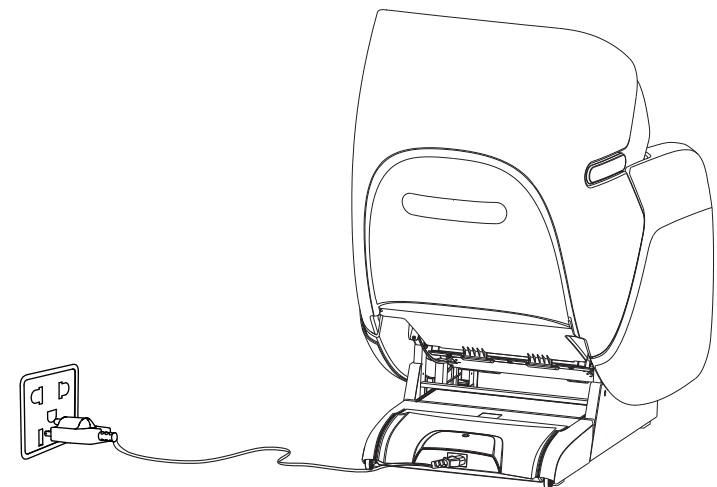

Moving the Massage Chair

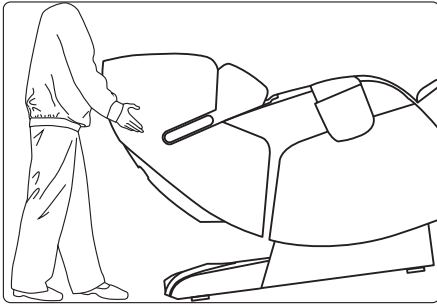

• As illustrated, push the backrest downwards and tilt the chair onto its wheels at a 45° angle. Slowly push and maneuver the massage chair to the desired location. Lower the chair slowly until it is fully flat on the floor.

Caution:

- Do not move the massage chair when occupied or in use.
- Moving the massage chair may damage

floors. We recommend moving the chair on rugs or carpeted floors.

- Do not drop or suddenly let go of the chair when moving it, as this may damage the chair or the floor.
- We advise two people move the massage chair together.

Chair Placement

- When placing your massage chair, be sure to leave at least 4 in. of clearance between the back of the chair and any wall or other objects to allow it to recline safely.
- When using the massage chair, ensure there are no people, pets, or objects within 8 in. of the front of the chair to allow the footrest to extend safely.
- Place the massage chair on a carpet or other padded surface in order to avoid scratching or damaging the floor.

Caution:

- Keep the distance between the power socket and power switch within 5 feet.
- To avoid damage or injury, do not place the massage chair on a wet or uneven floor.

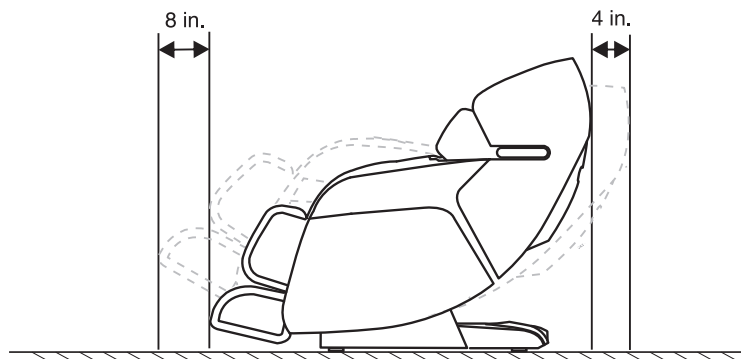

Remote Diagram

